

Parts Brochure

Keep your Sloan products working like new.

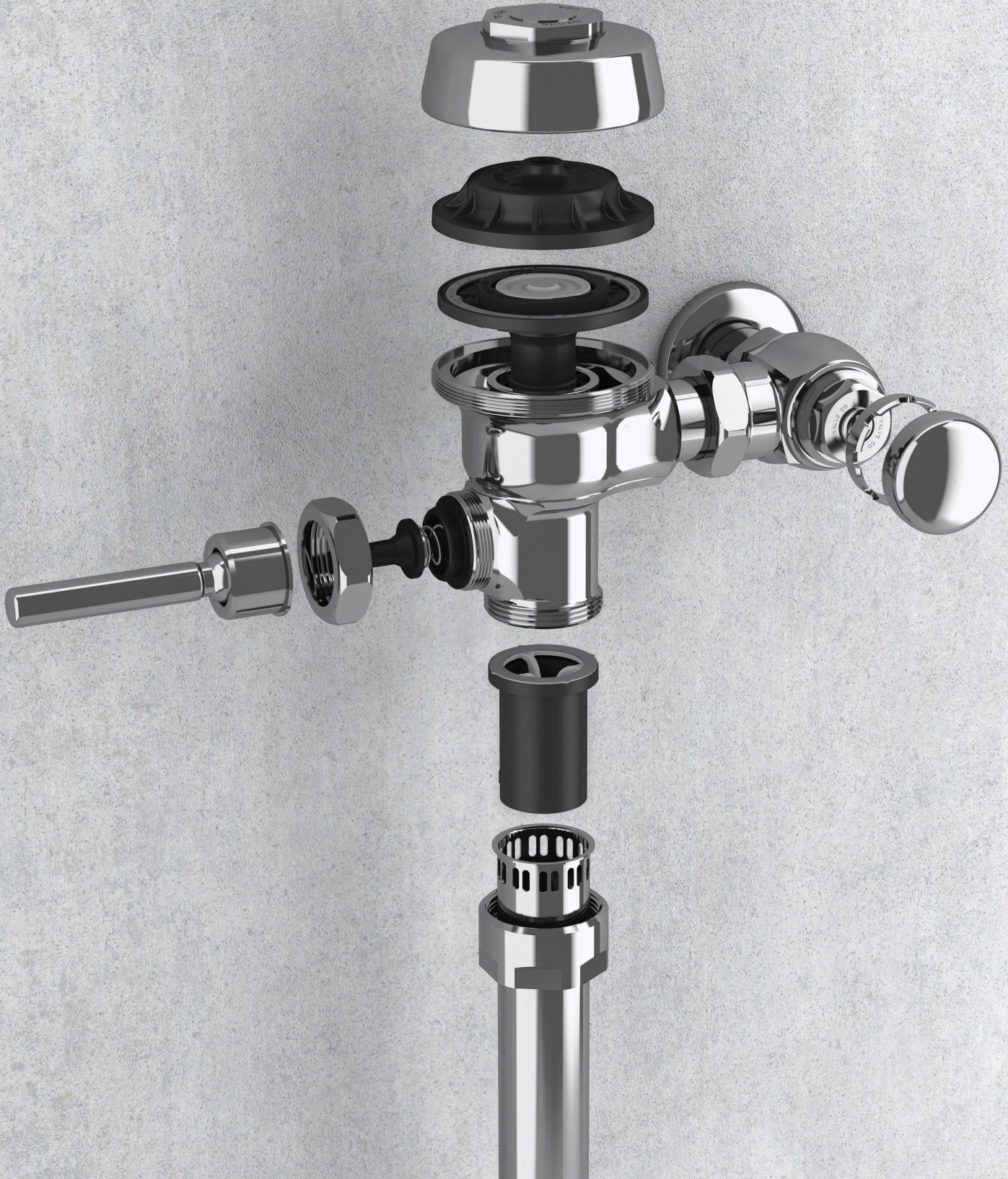



Extend the life of your Sloan® products

Our products perform at their highest levels when maintained exclusively using Sloan Genuine Parts. We offer the largest selection of parts, manufactured and tested to Sloan specifications.

Best-in-class parts, specifically designed for the most reliable commercial restroom products, means fewer repairs, protecting your investments.

Table of Contents







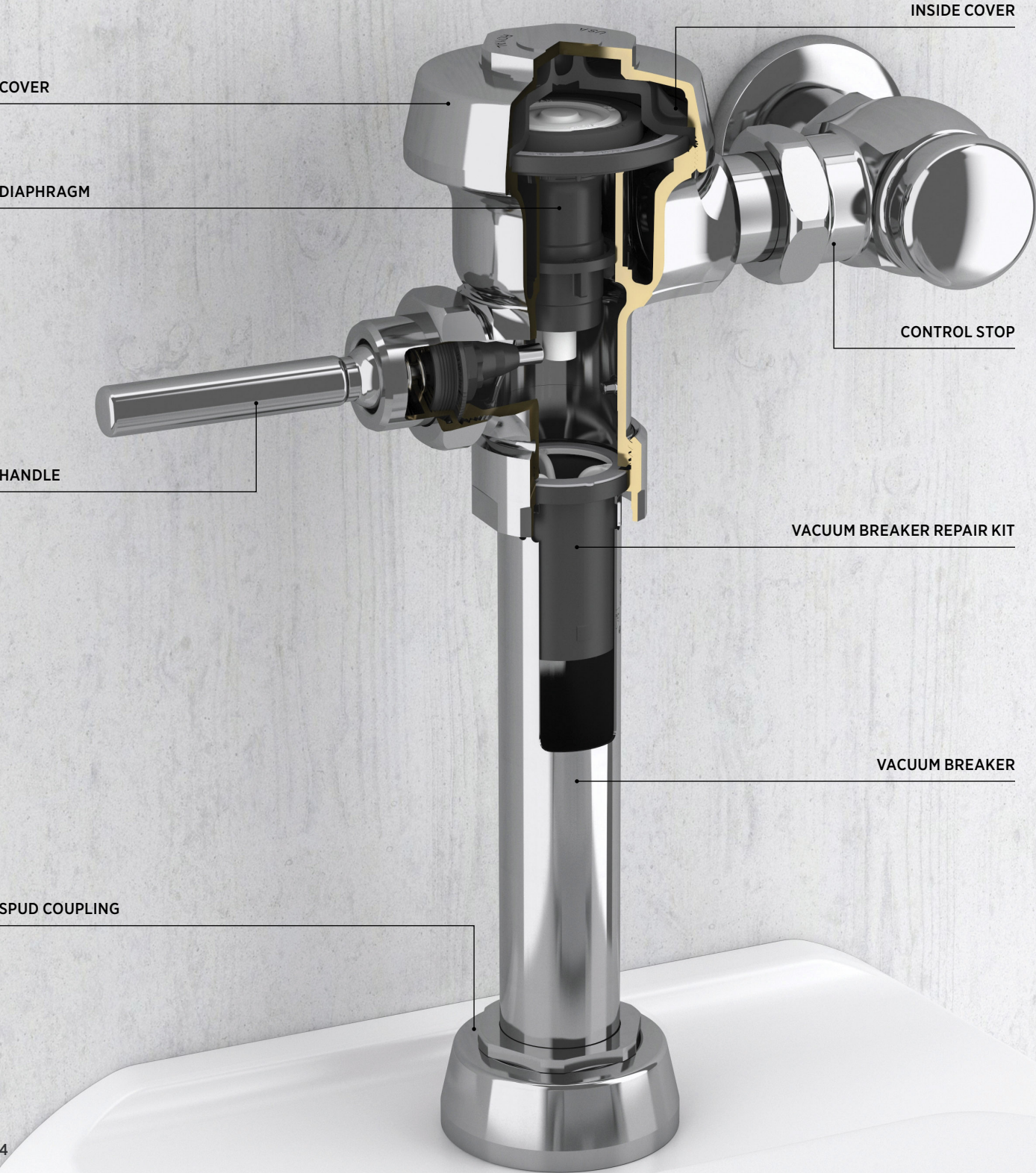

4-5	Royal®
6-7	Regal®
8-9	ECOS® & G2
10-11	SOLIS®
12-13	BASYS®, Optima®, Sloan®
14-15	Maintenance Guide

Royal[®]

The first of its kind. The best in its class.



DIAPHRAGM ONLY KIT

	3301143	A-1050-A	0.125 gpf (0.5 Lpf)
	3301142	A-1047-A	0.25 gpf (1.0 Lpf)
	3301124	A-1043-A	0.5 gpf (1.9 Lpf)
	3301123	A-1042-A	1.0 gpf (3.8 Lpf)
	3301119	A-1045-A	1.28 gpf (4.8 Lpf)
	3301120	A-1037-A	1.5 gpf (5.7 Lpf)
	3301122	A-1041-A	1.6 gpf (6.0 Lpf)
	3301125	A-1044-A	2.4 gpf (9.0 Lpf)
	3301121	A-1038-A	3.5 gpf (13.2 Lpf)

ROYAL COVER

	0301172PK	A-72
--	-----------	------

INSIDE COVER

	0301168	A-71
---	---------	------

* For use with 3/4" H-600-A BAK-CHEK® screwdriver control stop for urinals only (1964-1994).

** For use with 3/4" and 1" H-700-A BAK-CHEK screwdriver control stops (1995-present) or 1" H-600-A BAK-CHEK screwdriver control stop (1964-1994).

CONTROL STOP REPAIR KIT

	3308856*	H-543-ASD	3/4" (19 mm)
	3308853**	H-541-ASD	1" (25 mm)

VACUUM BREAKER REPAIR KIT

	3323183	V-651-A
---	---------	---------

VACUUM BREAKER

	3393004	V-600-AA	3/4" x 9" (19 x 229 mm)
	3393006	V-600-AA	1 1/4" x 9" (32 x 229 mm)
	3393007	V-600-AA	1 1/2" x 9" (38 x 229 mm)

SPUD COUPLING ASSEMBLY

	0306125	F-5-AW	3/4" (19 mm)
	0306140	F-5-AU	1 1/4" (32 mm)
	0306146	F-5-AT	1 1/2" (38 mm)

HANDLE

	3302003	B-51-A	Handle Repair Kit
	0302390	B-73-A	ADA Handle



Royal® Performance Kit

Includes dual-filtered fixed bypass diaphragm assembly, handle repair kit with triple seal packing, high back pressure vacuum breaker repair kit, and tailpiece o-ring.

3301073	A-1106-A	0.5 gpf (1.9 Lpf)	Urinals
3301070	A-1101-A	1.6 gpf (6.0 Lpf)	Water Closets



Royal® Tune Up Kit

Includes everything in the Royal Performance Kit with the addition of an inside cover.

3301188	A-1126-A	0.5 gpf (1.9 Lpf)	Urinals
3301184	A-1121-A	1.6 gpf (6.0 Lpf)	Water Closets

INSIDE COVER

COVER

DIAPHRAGM

CONTROL STOP REPAIR KIT

HANDLE

VACUUM BREAKER REPAIR KIT



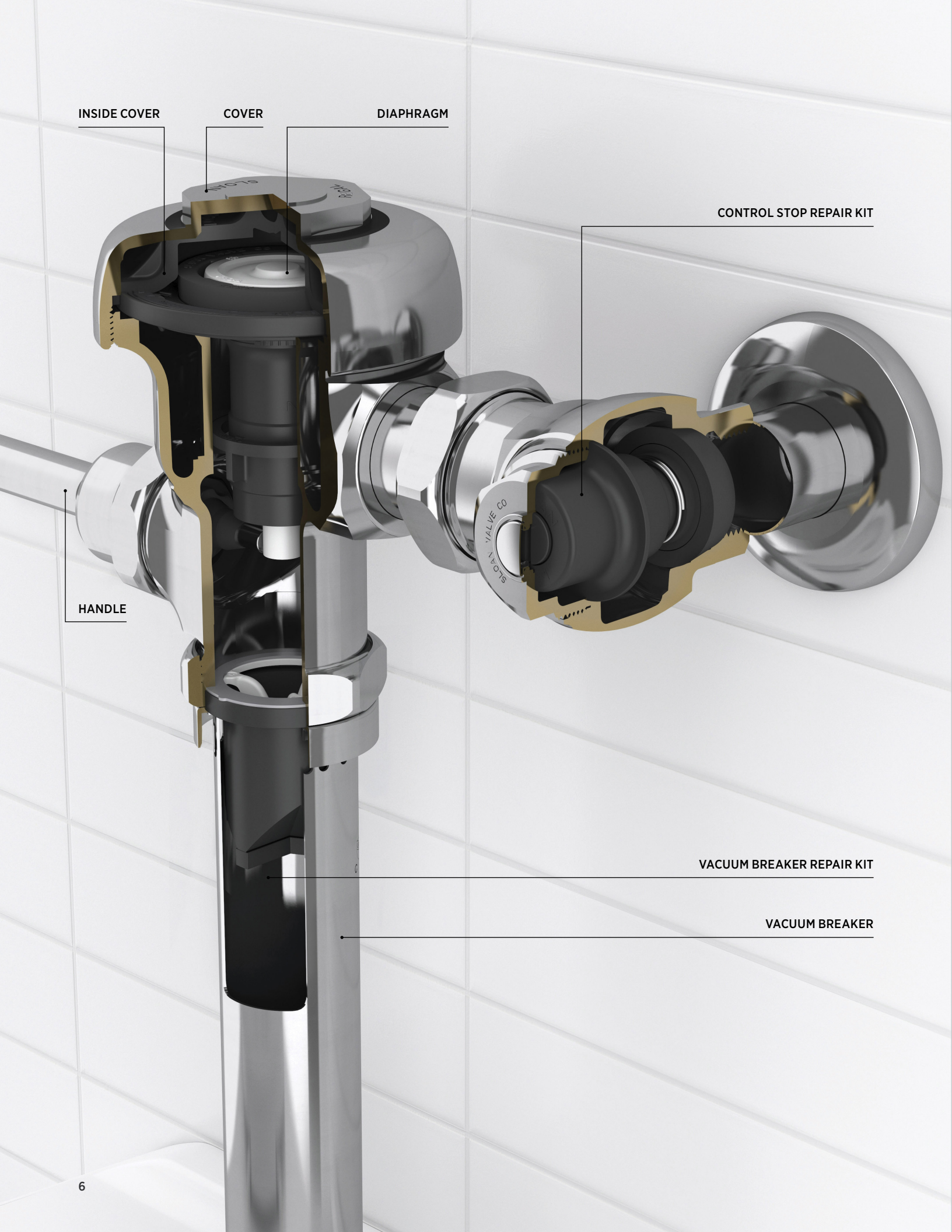





VACUUM BREAKER



Regal[®]

Reliable quality, design, and performance.

DIAPHRAGM ONLY KIT

	3301143	A-1050-A	0.125 gpf (0.5 Lpf)
	3301081	A-43-A	0.5 gpf (1.9 Lpf)
	3301044	A-42-A	1.0 gpf (3.8 Lpf)
	3301045	A-140-A	1.28 gpf (4.8 Lpf)
	3301037	A-37-A	1.5 gpf (5.7 Lpf)
	3301041	A-41-A	1.6 gpf (6.0 Lpf)
	3301024	A-44-A	2.4 gpf (9.0 Lpf)
	3301038	A-38-A	3.5 gpf (13.2 Lpf)
	3301036	A-36-A	4.5 gpf (17.0 Lpf)

REGAL COVER

	0317004	R-10
---	---------	------

INSIDE COVER

	0301168	A-71
---	---------	------

CONTROL STOP REPAIR KIT

	3308856*	H-543-ASD	¾" (19 mm)
	3308853**	H-541-ASD	1" (25 mm)

VACUUM BREAKER REPAIR KIT

	3323192	V-551-A
---	---------	---------

VACUUM BREAKER

	5323005	V-500-AA	¾" × 9" (19 × 229 mm)
	5323006	V-500-AA	1¼" × 9" (32 × 229 mm)
	5323007	V-500-AA	1½" × 9" (38 × 229 mm)

HANDLE

	5302305	B-50-A	Handle Repair Kit
	0302390	B-73-A	ADA Handle

SPUD COUPLING ASSEMBLY

	0306102	F-54-A	¾" (19 mm)
	0306142	F-55-A	1¼" (32 mm)
	0306145	F-56-A	1½" (38 mm)

* For use with ¾" H-600-A BAK-CHEK® screwdriver control stop for urinals only (1964-1994).

** For use with ¾" and 1" H-700-A BAK-CHEK screwdriver control stops (1995-present) or 1" H-600-A BAK-CHEK screwdriver control stop (1964-1994).

ECOS[®] & G2

Hands-free sensor operations with dual or single-flush options.



ECOS[®] COVER

OVERRIDE BUTTON ASSEMBLY

ELECTRONIC MODULE

LENS WINDOW

G2 COVER

VACUUM BREAKER

CONTROL STOP

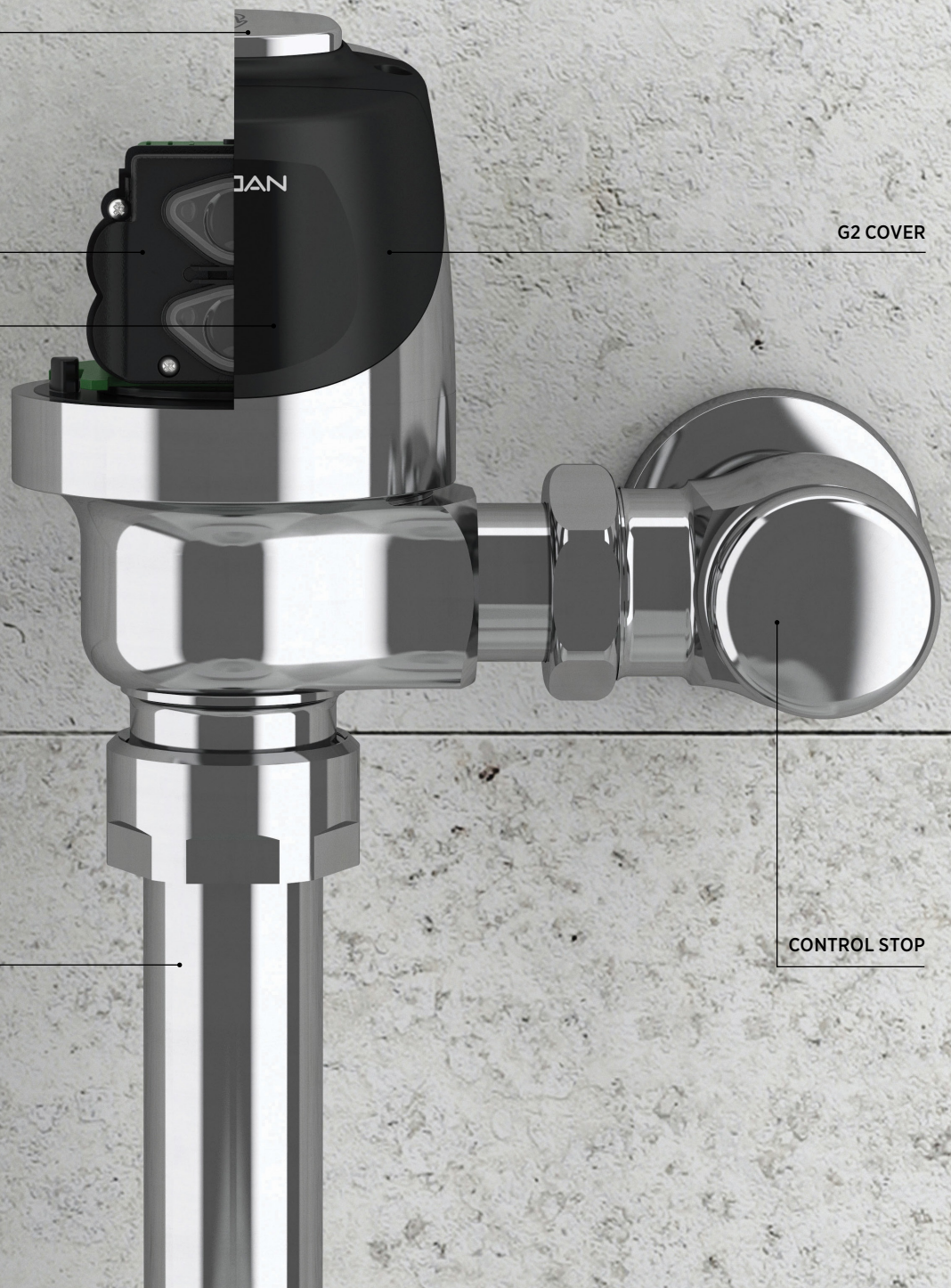







Parts can be used for ECOS® and G2 Flushometers, except where indicated.

BUTTON COVER ASSEMBLY

	0372033†	WES-23-A	Dual Flush
	0325172	EBV-130-A	Single Flush

FLEX-TUBE DIAPHRAGM KIT

	3325090	EBV-1025-A	0.125 gpf (0.5 Lpf) or 0.25 gpf (1.0 Lpf)
	3325003	EBV-1023-A	0.5 gpf (1.9 Lpf)
	3325000*	EBV-1022-A	1.0 gpf (3.8 Lpf) or 1.5 gpf (5.7 Lpf)
	3325031	EBV-1024-A	1.28 gpf (4.8 Lpf)
	3325001*	EBV-1020-A	1.6 gpf (6.0 Lpf) or 3.5 gpf (13.5 Lpf)
	3325014*	EBV-1021-A	2.4 gpf (9.0 Lpf)

CONTROL STOP REPAIR KIT

	3308856*	H-543-ASD	¾" (19 mm)
	3308853**	H-541-ASD	1" (25 mm)

VACUUM BREAKER

	3393004	V-600-AA	¾" × 9" (19 × 229 mm)
	3393006	V-600-AA	1 ¼" × 9" (32 × 229 mm)
	3393007	V-600-AA	1 ½" × 9" (38 × 229 mm)



COVER ASSEMBLY

	0325246†	EBV-191-A	Dual Flush
	0325168	EBV-142-A	Single Flush

LENS WINDOW COVER

	0325169	EBV-131	
---	---------	---------	--

ELECTRONIC MODULE

	3325450	EBV-129-AC	Water Closet* 1.28 – 3.5 gpf (4.8 – 13.2 Lpf)
	3325451	EBV-129-AU	Urinal* 0.5 – 1.5 gpf (1.9 – 5.7 Lpf)
	0325395†	EBV-386-AU	0.125 gpf (0.5 Lpf)
	0325396†	EBV-387-AU	0.25 gpf (1.0 Lpf)
	0325247†	EBV-196-A	1.6/1.1 gpf (6.0/4.2 Lpf)

VACUUM BREAKER REPAIR KIT

	3323183	V-651-A	
---	---------	---------	--

SOLENOID

	3325453	EBV-136-A	
---	---------	-----------	--

SPUD COUPLING ASSEMBLY

	0306125	F-5-AW	¾" (19 mm)
	0306140*	F-5-AU	1 ¼" (32 mm)
	0306146	F-5-AT	1 ½" (38 mm)

†ECOS *G2

* For use with ¾" H-600-A BAK-CHEK® screwdriver control stop for urinals only (1964-1994).

** For use with ¾" and 1" H-700-A BAK-CHEK screwdriver control stops (1995-present) or 1" H-600-A BAK-CHEK screwdriver control stop (1964-1994).

ELECTRONIC MODULE

COVER ASSEMBLY

VACUUM BREAKER REPAIR KIT

VACUUM BREAKER

SPUD COUPLING



SOLIS[®]

Solar-powered, sensor-operated.

COVER ASSEMBLY



0325311	EBV-311-A	Dual Flush
0325309	EBV-309-A	Single Flush

CONTROL STOP REPAIR KIT



3308856*	H-543-ASD	¾" (19 mm)
3308853**	H-541-ASD	1" (25 mm)

VACUUM BREAKER



3393004	V-600-AA	¾" × 9" (19 × 229 mm)
3393006	V-600-AA	1 ¼" × 9" (32 × 229 mm)
3393007	V-600-AA	1 ½" × 9" (38 × 229 mm)

SPUD COUPLING ASSEMBLY



0306125	F-5-AW	¾" (19 mm)
0306146	F-5-AT	1 ½" (38 mm)

FLEX-TUBE DIAPHRAGM KIT



3325090	EBV-1025-A	0.125 gpf (0.5 Lpf) or 0.25 gpf (1.0 Lpf)
---------	------------	--



3325003	EBV-1023-A	0.5 gpf (1.9 Lpf)
---------	------------	-------------------



3325000	EBV-1022-A	1.0 gpf (3.8 Lpf) or 1.5 gpf (5.7 Lpf)
---------	------------	---



3325031	EBV-1024-A	1.28 gpf (4.8 Lpf)
---------	------------	--------------------



3325001	EBV-1020-A	1.6 gpf (6.0 Lpf) or 3.5 gpf (13.5 Lpf)
---------	------------	--

ELECTRONIC MODULE



0325312	EBV-312-AC	Water Closet
---------	------------	--------------

0325313	EBV-312-AU	Urinal
---------	------------	--------



0372038	WES-33-A	Water Closet Dual Flush
---------	----------	----------------------------

VACUUM BREAKER REPAIR KIT



3323183	V-651-A	
---------	---------	--

SOLENOID



3325453	EBV-136-A	
---------	-----------	--

* For use with ¾" H-600-A BAK-CHEK® screwdriver control stop for urinals only (1964-1994).

** For use with ¾" and 1" H-700-A BAK-CHEK screwdriver control stops (1995-present) or 1" H-600-A BAK-CHEK screwdriver control stop (1964-1994).

Faucet Parts

Engineered parts to maximize the performance of Sloan Faucets.



BASYS® FAUCET CROWN

EFX	3324118	EFX-1-A	Standard Crown Kit (1R)
EFX	3324119	EFX-3-A	Crown Kit (Solar)

BATTERY

EAF	3335018	EAF-1003-A	EAF-250/275/350/750
EAF	3335009	EAF-1000-A	EAF-100/150

BELOW DECK CONTROL BOX

EBF*	3315111	EBF-11-A	Sol. Valve Module ASM Labeled
ETF*	3365000	ETF-450-A	Splash Proof Junction Box
EBF*	0365752	ETF-735-A	Junction Box/Splash Proof ASM
EBF*	0315104	EBF-60-A	Control Module w/ Solenoid
SF	0362040	SFP-40-A	Control Box w/ Range Adj. (6 Pin)

BOX MOUNT TRANSFORMER

ETF*	0345125	EL-451	120 VAC/6 VAC-25 VA
EAF	0335037	EAF-37	100-240 VAC/6 VDC Box Mount

CHECK VALVE KIT

ETF*	3365001	ETF-470-A	$\frac{3}{8}$ Comp Single-inlet Check Valve Kit
------	---------	-----------	---

* Legacy Optima® faucets prior to 08-2018

 **GRID STRAINER DRAIN**

ETF* 0365036PK ETF-460-A ASM

 **PLUG ADAPTER**

EAF/EFX 0335009 EAF-11 100-240 VAC/6 VDC Plug-in

ETF* 0365534PK ETF-233 120/24 VAC 35 VA Plug-in

 **POWER SPLITTER**

EAF 0335044 EAF-44 Power Splitter EAF-100/200/700

 **SENSOR ASSEMBLY**

EAF 0335013 EAF-14-A Solar w/o Click (EAF-275)

ETF* 3365460 ETF-1019-A-LL Micr. Sen./Box Kit L/ Logo

EAF 0335002 EAF-3-A Battery w/o Click (IQ)

SF 0362041 SFP-41-A w/ Range Adj. (6 Pin)

ETF* 0305946PK EL-3500-A Microphone

ETF* 3305623 EL-1500-LLT Rep. Kit Lav. w/ Timeout

EAF 0335003 EAF-4-A Battery w/ Click (IQ)

EAF 0335014 EAF-16-A Solar w/ Click (EAF-275)

ETF* 3305622 EL-1500-LL Repair Kit Lavatory

 **SPOUT ASSEMBLY**

EBF* 3315016 EBF-10-A Spout Sub-ASM (EBF-85)

 **TEMPERATURE MIXING VALVE**

ALL 3326009 MIX-60-A Mechanical Mixing Valve

ALL 0326045PK MIX-135-A Thermostatic Mixing Valve

 **TRIM PLATE**

ETF* 3365468 ETF-312-A 4" Cent. 1 HL

ETF* 3365024 ETF-510-A 8" Cent. 1 HL

 **SINK ENCLOSURE**

ALL 0365059 ETF-529 Lavatory Protection

 **SOLENOID VALVE**

EAF 0335001 EAF-2 Solenoid Cartridge (FCT)

NEW OPTIMA 0367103 EFP-103-A Solenoid Caddy Repair Kit

EBF* 0365758 ETF-740-A 6 VDC Solenoid Valve Assembly, 3/8 Comp.

ETF* 0305849PK ETF-370-A 24 VAC Solenoid Valve Assembly

ETF* 0365774 ETF-742-A Solenoid 6 VDC w/ Cable

EBF 3315254 EBF-1011-A Rep. Kit Bat. (EBF-60-A)

ETF* 3305577 ETF-1009-A 24 VAC Solenoid Rebuild Kit (ETF-370-A)

EFX 3324123 EFX-16-A Solenoid Caddy Kit 1.5 Mid IR

EFX 3324122 EFX-15-A Solenoid Caddy Kit 0.5 Mid IR

Family Guide









Faucet parts within each family line

BASYS®		OPTIMA®		SLOAN®
EFX	EBF	ETF	EAF	SF
EFX-1XX	EBF-85	ETF-80	EAF-1XX	SF-21XX
EFX-2XX	EBF-187	ETF-880	EAF-2XX	SF-22XX
EFX-3XX	EBF-550	ETF-500	EAF-3XX	SF-23XX
EFX-6XX	EBF-615	ETF-610	EAF-7XX	SF-24XX
EFX-8XX	EBF-650	ETF-600	EAF-9XX	
	EBF-665	ETF-660		
	EBF-750	ETF-700		
	EBF-775	ETF-770		
	EBF-850	ETF-800		

Maintenance Guide



Flushometer and faucet parts schedules for optimal performance.

Manual diaphragm flushometers

LIFE EXPECTANCY Industry Standard / Sloan Standard		MAINTENANCE INDICATOR	3/4+ years	3/5+ years	15/20+ years
	Handle assembly Internal parts	<ul style="list-style-type: none"> Leaking around the handle Drooping handle Short erratic flush 	✓		
	Vacuum breaker Internal (baffle and sack)	<ul style="list-style-type: none"> Leaking around the vacuum breaker vent holes during or after flush cycle 	✓		
	Inside cover	<ul style="list-style-type: none"> Slow leaks into the fixture Flush cycle too long or too short Grooves cut into inner cover from diaphragm segments 	✓		
	Diaphragm kit Regal®	<ul style="list-style-type: none"> Slow leaks into the fixture Flush cycle too long or too short 	✓		
	Diaphragm kit Royal®/Sloan®	<ul style="list-style-type: none"> Slow leaks into the fixture Flush cycle too long or too short 		✓	
	Stop assembly Internal parts	<ul style="list-style-type: none"> Leaking around the stop Failure to completely shut off water Excessive wrench marks on bonnet 		✓	
	Brass parts Body, outside cover, stop, and vacuum breaker tube	<ul style="list-style-type: none"> Compromised chrome finish Missing or distorted threads 			✓
	Flanges & connections	<ul style="list-style-type: none"> Compromised chrome finish Missing or distorted threads Excessive wrench marks on coupling Leaking around connections 			✓



Battery-powered diaphragm flushometers

Same as manual diaphragm flushometer with exception of following parts

LIFE EXPECTANCY Industry Standard / Sloan Standard		MAINTENANCE INDICATOR	3/4+ years	3/6+ years	5/7+ years	20/25+ years
	Batteries-alkaline	<ul style="list-style-type: none"> Blinking LED Unit will not flush 		✓		
	Sensor ring cover assembly Includes solenoid	<ul style="list-style-type: none"> Unit will not flush Unit will continuously leak into fixture 			✓	

Hardwired diaphragm flushometers

Same as battery-powered diaphragm flushometer with exception of following parts

LIFE EXPECTANCY Industry Standard / Sloan Standard		MAINTENANCE INDICATOR	3/4+ years	3/6+ years	5/7+ years	20/25+ years
	Actuator cartridge assembly	<ul style="list-style-type: none"> Leaking around button upon activation Sensor and solenoid work, but will not flush 	✓			
	Solenoid	<ul style="list-style-type: none"> Unit will not flush Unit will continuously leak into fixture 			✓	
	Transformer	<ul style="list-style-type: none"> Unit will not flush at all, no power to the sensor 				✓



Hydraulic actuator flushometers

Same as manual diaphragm flushometer with exception of hydraulic push button assembly

LIFE EXPECTANCY Industry Standard / Sloan Standard		MAINTENANCE INDICATOR	3/4+ years	3/5+ years
	Hydraulic push button assembly	<ul style="list-style-type: none"> Leaking around the button upon activation 	✓	

Manual piston flushometers

Same as manual diaphragm flushometer with exception of piston kits

LIFE EXPECTANCY Industry Standard / Sloan Standard		MAINTENANCE INDICATOR	3/4+ years	3/5+ years
	Piston kit-GEM-2®	<ul style="list-style-type: none"> Slow leaks into the fixture Flush cycle too long or too short 	✓	
	Piston kit-Crown®	<ul style="list-style-type: none"> Slow leaks into the fixture Flush cycle too long or too short 		✓

Faucets

LIFE EXPECTANCY Industry Standard / Sloan Standard		MAINTENANCE INDICATOR	3/4+ years	3/5+ years
	Solenoid	<ul style="list-style-type: none"> Slow leak No flow Continuous run-on 		✓



Water Connects Us®

World Headquarters

10500 Seymour Avenue
Franklin Park, IL 60131
U.S.A.

800.982.5839
sloan.com

Follow Sloan

f /sloanvalvecompany

t @sloan_valve

@ @sloan_valve

p /sloan_valve

in /sloan-valve-company